

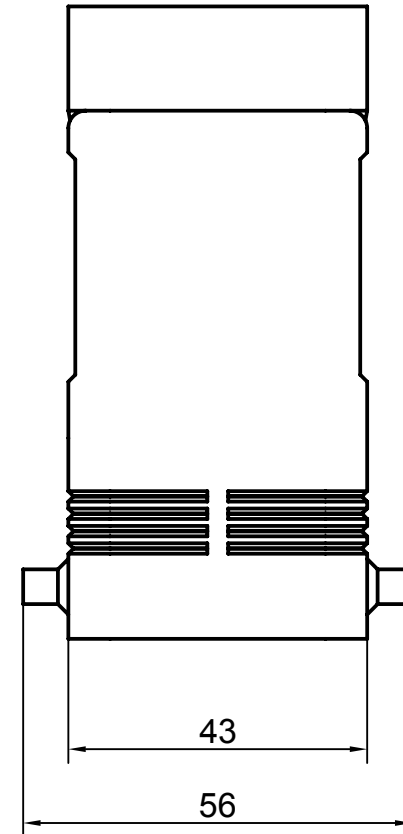

Diritti riservati

All rights reserved

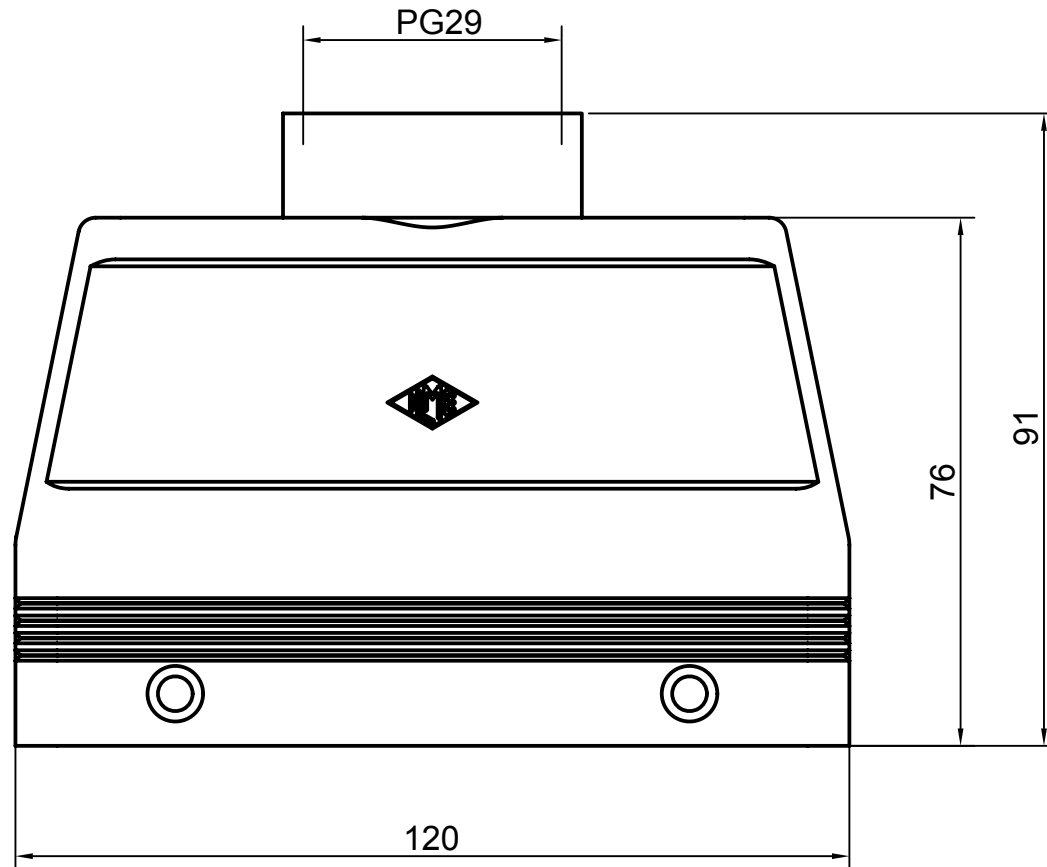

Date 14.12.2006	CMAV 16.29	Scale	
Sign.	hood top entry PG29 ins.	1:1	